

AN OVERVIEW OF RADON - A GUIDE FOR INSTALLING RADON CONTROL SYSTEMS IN NEW HOMES

Douglas L. Kladder and James F. Burkhart
Western Regional Radon Training Center
Colorado Springs, CO

Philip F. Rieg
Colorado Vintage Companies, Inc.
Colorado Springs, CO

ABSTRACT

The U.S. EPA's Model Standards and Techniques for Control of Radon in New Residential Buildings has provided an excellent basis for the application of radon resistant techniques for new homes. Since these methods were developed in 1994, innovations by the radon and building industry along with local construction practices have provided an additional base of experience to enhance the US EPA's original approach. The Western Regional Radon Training Center has assembled this information into a design guidance document for use by architects and as an installation guide for builders and their crews to follow during the construction of a new building.

This new document includes mechanical soil gas collection techniques as alternatives to washed gravel; effective stack routing for passive systems; and the application of these techniques to large footprint structures.

The document follows this abstract in its entirety for use by radon professionals and public health officials. It has been modified for the State of Colorado and can be found on the Internet at <http://www.cdphe.state.co.us/lr/builder.htm#top>.

Radon

*An Environmental Concern
With An Easy Solution!*

*A guide for installing
affordable radon control
systems in new homes*



A Partnership Between the
Environmental Protection Agency and the
Western Regional Radon Training Center

Western Regional Radon Training Center and the U.S. Environmental Protection Agency

The Western Regional Radon Training Center at the University of Colorado at Colorado Springs is committed to fostering healthy indoor environments for all segments of the population. Since this is also a national goal for the U.S. Environmental Protection Agency, the two entities have entered into a partnership to accomplish their common goal by transferring and sharing radon technology.

Radon: A gas that causes lung cancer

Radon is a radioactive gas that can enter homes. Prolonged exposure to this gas can increase the potential for lung cancer. Radon is believed to cause approximately 14,000 to 21,000 lung cancer deaths per year in the U.S.

Purpose of booklet

This booklet was developed by the U.S. EPA's Western Regional Radon Training Center in order to provide a simple, step-by-step manual that can be used to plan and install radon reduction systems.

Basis of technology

Over the last 15 years, considerable research has been devoted to developing cost-effective techniques for reducing radon levels in homes. This research has yielded reliable methods that can be applied to both new and existing homes.

Radon is an equal opportunity hazard!

Radon can be a health hazard in any home, regardless of its age or the income level of its occupants. The methods outlined in this booklet are not only effective, they are also affordable. When these radon reduction methods are combined with good building practices, the result is a well designed home which will go a long way in providing a healthy home environment.

Technical questions can be answered by calling the Western Regional Training Center at the University of Colorado at Colorado Springs at (800) 513-8332.

Published June 1998

What is radon?

Radon is a gas created in the soil from trace amounts of uranium and radium in the soil. These elements can be found everywhere in the world. Therefore, any building has the potential for elevated levels of radon. It is usually not a question of "Is there radon?" but rather, "How much radon is there?"

Radon comes from natural deposits of uranium and radium in the soil. Typically, it is not a result of manmade landfills or other suspicious sources.

Uranium breaks down to radium, which in turn decays into radon gas. Radon is an inert gas, which means that it does not react or combine with the elements in the ground. Because of this, radon gas can move up through the soil into the atmosphere, where it is easily diluted. However, when it enters a building constructed on top of this soil, it can build up and become a health concern.

People cannot see, taste or smell radon. There is no way that one can sense the presence of radon. Despite this, it can have a detrimental effect on people by increasing their likelihood of developing lung cancer.

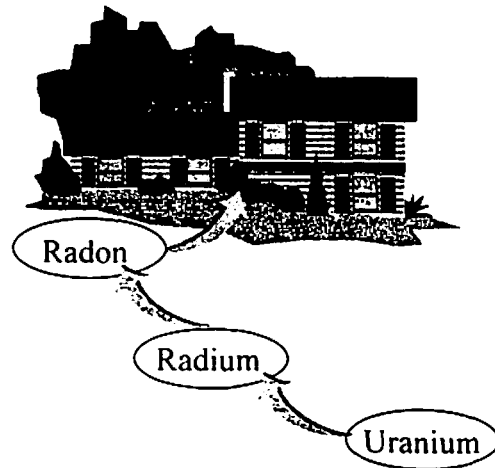

How does radon enter a building?

Buildings are typically at a lower pressure than the surrounding air and soil. This causes radon and other soil gases to be drawn into the building.

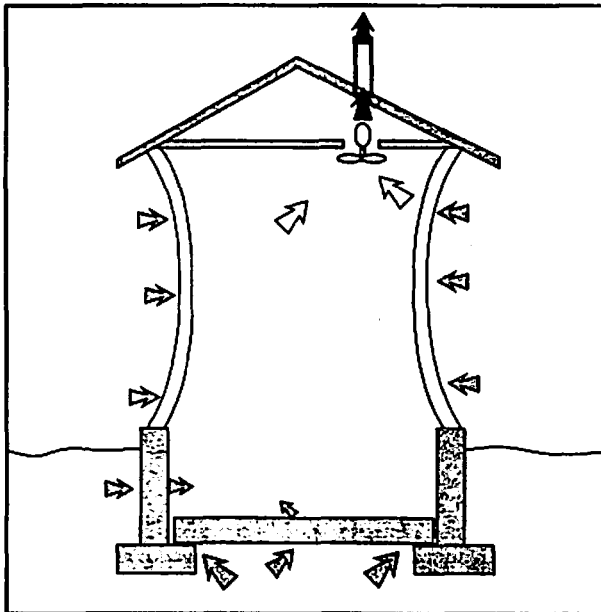

There are several reasons why this occurs. One reason is the effect that exhaust fans have when removing air from a building. When air is exhausted, outside air enters the building to replace it. Much of this replacement air comes in from the underlying soil.

A second reason that radon is drawn into a building is because when the indoor temperatures are higher than the outdoor temperatures, thermal effects occur inside the building. Just as warm air causes a balloon to rise because the surrounding air is cool, warm air rises within a building and is replaced by cold, dense outside air. Some of the

outside air, which is displacing and replacing the interior air, moves through the soil and carries radon in with it.

Does the type of foundation affect radon entry?

Because radon is literally sucked into a home, any house that is in contact with soils can potentially have a radon problem.

Basements:

Radon can enter through cracks in the slab, especially at floor-to-wall joints and control joints.

Slab-on-grade houses:

Vacuums occur in homes regardless of whether or not there is a basement. Slabs built on-grade can have just as many openings that allow radon to enter.

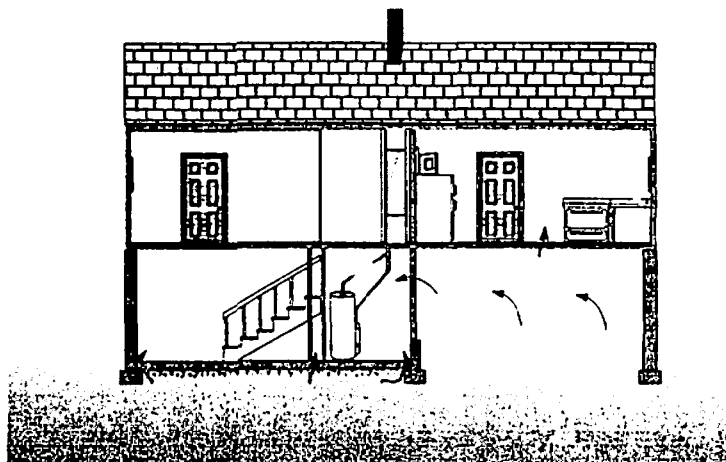

Crawl space homes:

The vacuum that exists within a home is exerted on the crawl space beneath it, causing radon and other gases to enter the home from the earthen area below. Even with crawl space vents, a slight vacuum is still exerted on the crawl space. This vacuum is sufficient to draw radon from the exposed earth.

Mobile and pre-fabricated homes: Unless set up on piers without any skirting placed around them, interior vacuums can cause radon to enter these types of homes as well.

So can't we just seal up cracks to keep radon out?

Field research has shown that attempting to seal all of the openings in a foundation is not only impractical but does not work as a stand-alone technique. Because of the vacuums that exist in homes, radon can enter through very small cracks and openings. These small cracks and openings are too small to locate and effectively seal. The photo on the right shows an example of how difficult it would be to access and seal some slab openings and plumbing penetrations.

Realize that even if you did manage to seal everything up, which would be very expensive, building settlement causes new cracks to occur and negates all previous sealing work.



Plumbing penetrations through plates

So if you can't seal out radon, how do you fix a house?

You can install what is referred to as an "active soil depressurization system," which extracts radon laden soil gases and vents them to a safe location outside of the house.

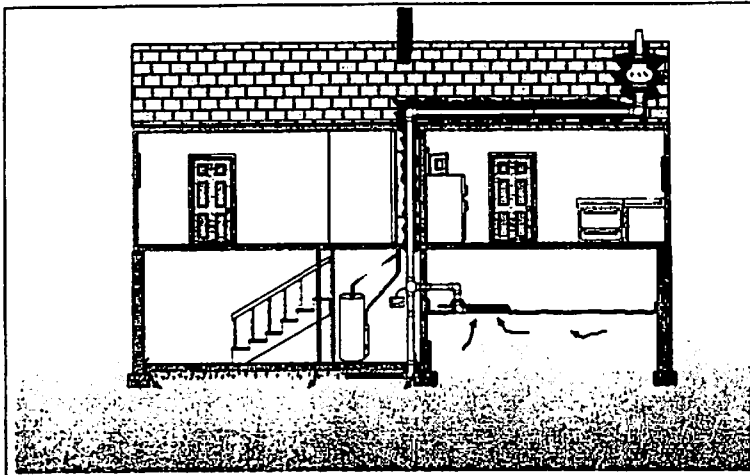

**Active Soil Depressurization System
Treating Both Slab And Crawl Space**

The objective of this system is to create a vacuum beneath the foundation that is greater in strength than the vacuum applied to the soil by the house itself. The illustration on the left shows how this is done to a house that has both basement and crawl space areas from which radon can enter. On the basement side, a PVC pipe is inserted into a pit dug beneath the basement slab. In the case of an existing home or where compacted

fill has been used, it is difficult for radon to move through the soil beneath the slab without the use of a fan (located in attic) to draw it out.

On the crawl space side, a sheet of plastic can be laid on the exposed soil, with the edges sealed against the foundation walls. This allows for the collection of the radon before it enters the crawl space and the living space above, and for exhaustion of the radon above the house.

If active soil depressurization works, why not wait until after the building is constructed to see if a system is needed?

While constructing a new home, you have the opportunity to prepare the sub-grade below a slab so radon can move more easily to the riser. Also, the riser is routed through a warm space (such as the furnace flue chase), which will create a draft in the pipe. The combination of these two factors often allows the system to operate passively (without the need for a fan).

Another reason to install a system during construction is that the pipe can be run more easily before the house is finished. This significantly improves aesthetics and reduces subsequent system operating costs.

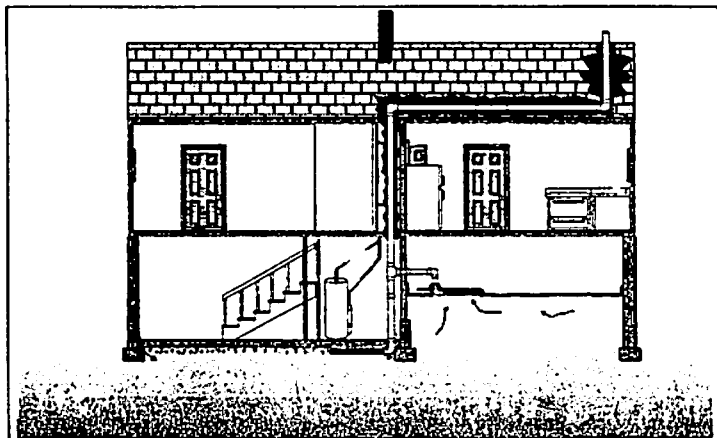

Passive System For New Homes

What if the passive soil depressurization system is not adequate?

If you plan ahead by making provisions for a future fan, it is easy to add if a post-construction radon test indicates a need to boost the system's performance. The two photographs below show how this can be done.



Passive system piping

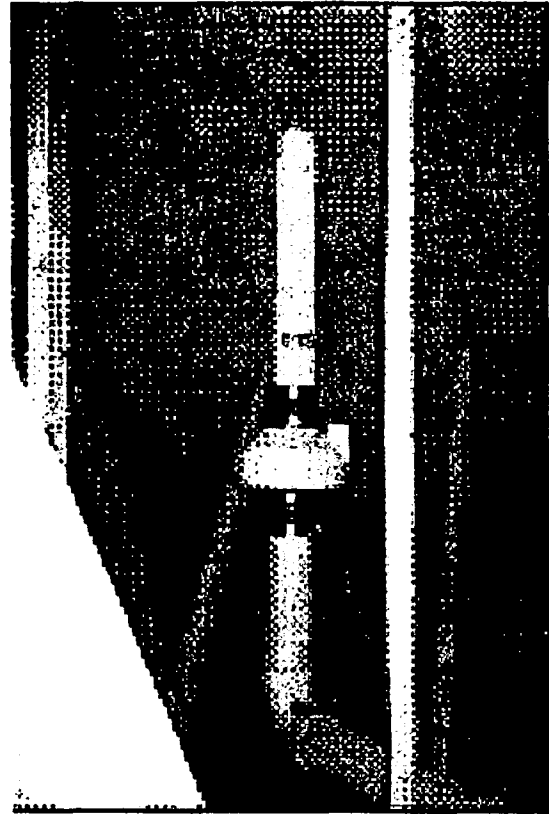

Same system with fan added later

Might we be incurring some liability by installing passive radon systems?

By installing these systems you are being proactive and reducing potential liability. Disclose the presence of the system and the need for the occupant to test the home for radon, to ensure that it is adequately reducing radon to less than the U.S. EPA's long-term guidance of 4.0 pCi/L. In this way, you will be meeting and exceeding most states' disclosure requirements.

Are there other benefits of installing these systems?

These systems are very good at reducing moisture influx from the soil. This can reduce the generation of molds and mildews and other indoor air quality problems. In areas where expansive soils are prevalent, this moisture reduction can reduce foundation pressures and prolong the life of the foundation.



Since people are more routinely asking about radon at the time of purchasing a home, a radon reduction system is no longer a stigma to resale, but an asset.

Can all homes benefit from a radon system?

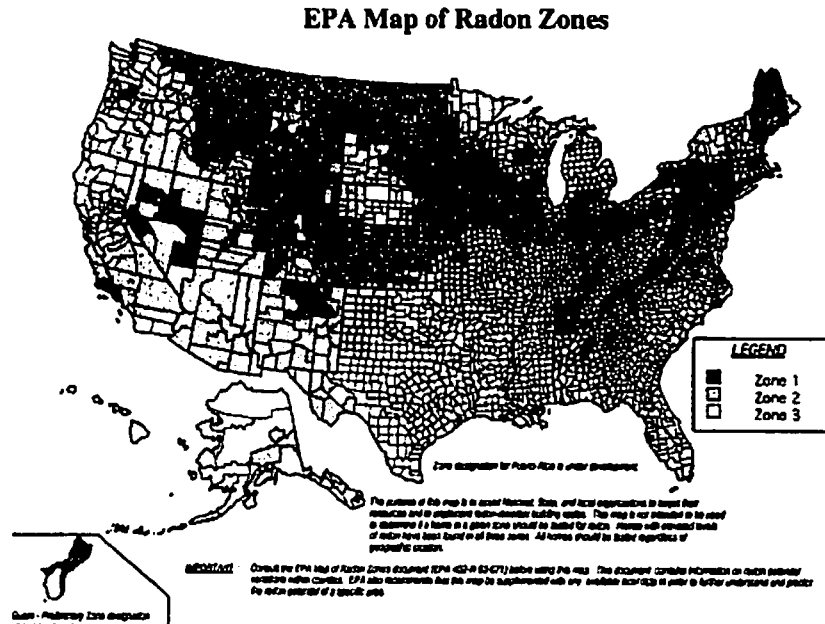
The potential for elevated radon is not uniform throughout the country. Although you can never be certain that a radon problem will not exist, the U.S. EPA and the U.S. Geological Survey have identified areas of the country where the odds are the greatest of having a radon concern. The map below is the result of their analysis of indoor radon measurements, local geology, and population densities in an effort to rank radon potentials as a function of political boundaries (county lines). The map indicates three radon potential zones, defined by the likelihood of finding radon measurements within certain ranges when a short-term, closed building radon test is performed.



U.S. EPA Map of Radon Zones¹

Color Key	Zone	Range of radon measurements (short-term, closed building)
	1	Greater than 4.0 pCi/L
	2	Between 2.0 and 4.0 pCi/L
	3	Less than 2.0 pCi/L

Is there any way to test a lot before building?

Although soil testing is possible, one cannot predict the impact that the site preparation will have on the introduction of new radon pathways, or the amount of vacuum a house will create. In addition, the cost of such testing is very high when compared to the costs of installing passive radon systems in areas with high radon potentials. In areas with a high incidence of elevated radon it would be prudent to install the systems described in this booklet.

¹ Map indicates where radon resistant new construction would be cost-effective. It should not be used to determine where radon testing should occur. The U.S. EPA recommends that all homes be tested for radon.

Treating Slab-On-Grade and Basement Slabs

The key to making a passive radon reduction system work is to ensure that radon and other soil gases can easily move laterally beneath the slab. There are three basic methods for improving soil gas collection beneath slabs:

- A four inch layer of clean aggregate beneath the slab;
- A loop of perforated pipe in native soils beneath the slab;
- Interconnected strips of "soil gas collector mat" on top of the sub-grade and beneath the slab.

Which method is chosen is purely a function of economics and time. The following discussion provides guidance for choosing between the options and describes methods for installation.

Gravel option:

A continuous four inch layer of ½-inch to ¾-inch washed gravel beneath a slab provides a largely unrestricted path in which radon can be collected. This option is generally chosen in regions of the country where gravel is plentiful and economical, or when gravel is specified as a capillary break for water drainage by the foundation engineer.

Design Parameter - gravel beneath slabs

When using gravel it is important that wet concrete not be allowed to flow down into the gravel and restrict the air flow. This can be accomplished by laying a sheet of 6 mil plastic or geotechnical cloth on top of the gravel to prevent the mud from percolating down. One can also use an additional two inches of gravel (for a total of 6-inch nominal depth) to accomplish the same result.

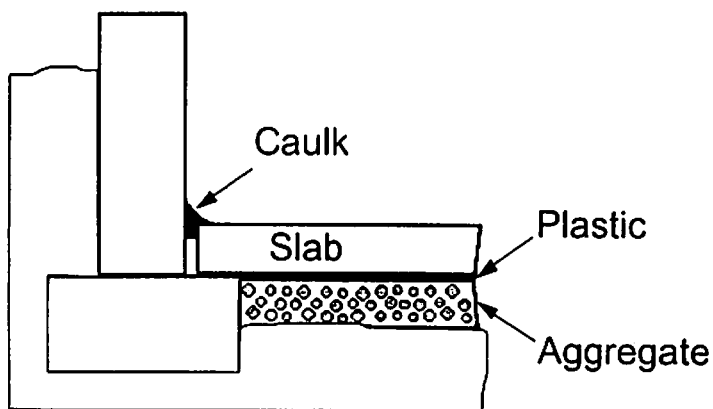

If plastic is used, be sure that the concrete can de-water as it cures from the bottom side of the slab, otherwise in dry and warm climates the slab may crack. Concrete workers will typically poke de-watering holes in the plastic and ensure that the plastic is not sealed to the foundation walls. The seal that isolates the sub-grade area from the

interior of the home is put in place by applying caulk to the floor-to-wall and control joints, after the slab has cured.

Design Parameter - avoiding grade beam obstructions

Often a grade beam or intermediate footing is installed beneath a slab to provide support for a load bearing wall. However, a grade beam or footing can be a barrier in the lateral flow of air toward the collection point of the system. This can be avoided by using post and beam construction, where teleposts that support overhead beams are set on pads rather than on continuous footings.

If a continuous grade beam is used, a means to allow air to flow through the grade beam must be provided. This is typically accomplished by inserting at least two 4-inch pipe sleeves between the form boards or trench, and pouring the grade beam over them. A minimum of two pipes should be installed, spaced at opposite ends of the grade beam with additional pipes every 10 feet. The pipe can be 4-inch schedule 40 PVC or 4-inch corrugated ADS (Advanced Drainage System) pipe. Be sure to tape the ends so concrete does not enter the pipe while pouring the footing. Remove tape, after forms are removed, before connecting to the pipe loop.

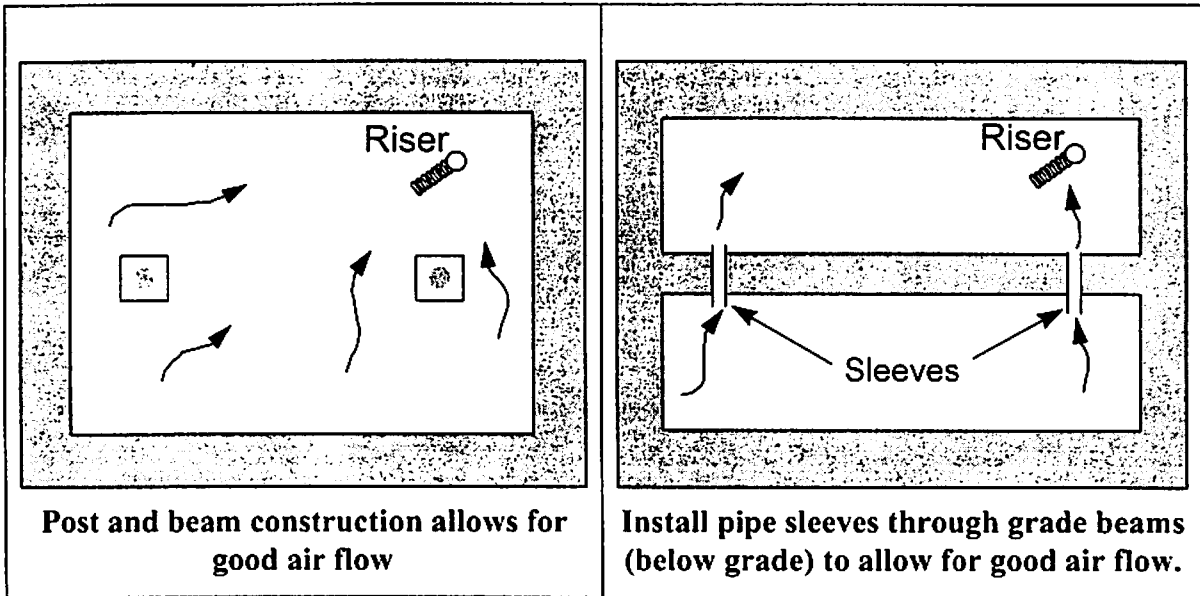

Design Parameter - connecting vent pipe to gravel

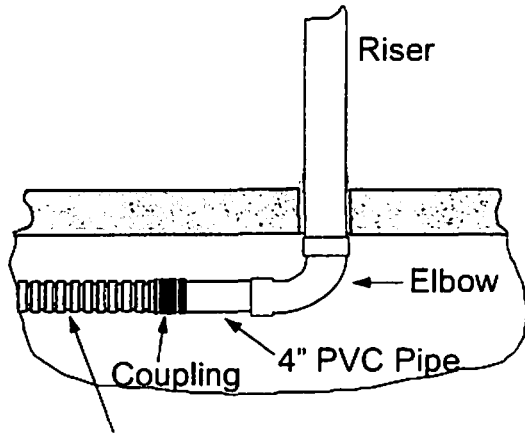

4" Corrugated & Perforated Pipe

A length of 4-inch perforated and corrugated ADS pipe (minimum 10 feet long) should be laid in the gravel (be sure concrete does not plug this off when poured) and connected to the radon vent riser. Sticking the pipe directly into gravel or with a short elbow has the potential of restricting air flow. The illustration to the left shows how a corrugated pipe can be connected to a short stub of 4-inch PVC via a 4-inch by 4-inch rubber coupling.

Perforated Pipe Option for Treating Slabs:

In some regions of the country native soils are permeable enough to not require the importation of gravel for water drainage. In other areas, the importation of gravel is very expensive. In the case where gravel is not already being used or is expensive, it may be more cost-effective to use native fills beneath the slab and improve soil gas movement by laying in a loop of perforated pipe. This works well because the soil gases need only move to the loop rather than all the way across the slab (as would be the case if a single collection point was used).

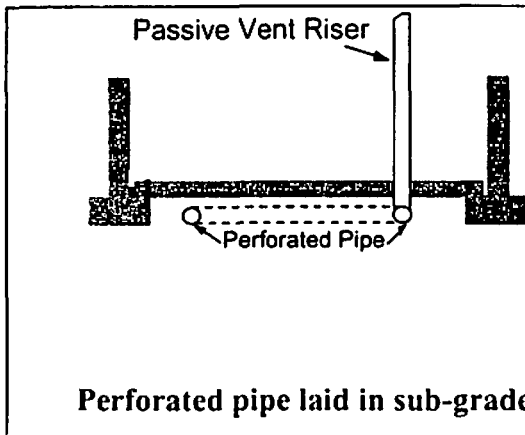

Perforated pipe laid in sub-grade



Photo of pipe being laid in trench

Design Parameter - pipe loop material and size

For slab areas less than 2,000 square feet, a continuous loop of 3-inch diameter perforated pipe should be laid in the sub-grade, with the top of the pipe located a nominal 1 inch below the concrete slab. The pipe loop should be located approximately 12 inches from the inside of the perimeter foundation walls.

For slab areas greater than 2,000 square feet but less than 4,000 square feet, the same configuration may be used but the pipe size should be a minimum of 4 inches in diameter. Slab designs in excess of 4,000 square feet should have separate loops for each 2,000 or 4,000 square feet, depending upon the size of pipe utilized (3-inch or 4-inch).

Perforated and corrugated ADS pipe is flexible, which makes it is easy to lay down in a trench. The perforations also allow for good soil gas collection. Be sure the pipe is covered by at least 1 inch of fill to keep concrete from clogging perforations.

Design Parameter - install in loop rather than straight sections

Laying the pipe out in a loop allows for the soil gas to enter the collection pipe from two sides. In addition, if the pipe is crushed at some point during construction, the soil gas will still be drawn to the vent pipe.

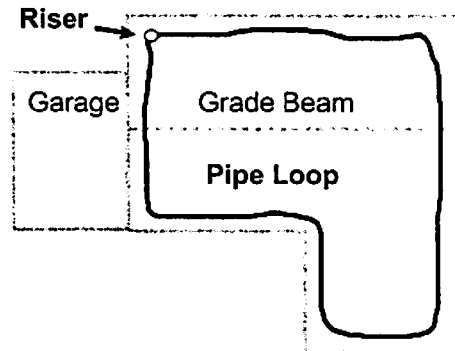

Design Parameter - crossing grade beams

In buildings where interior footings or other barriers separate the sub-grade area, the loop of pipe shall penetrate, or pass beneath, these interior footings or barriers. This can be accomplished by laying the loop in before the grade beams are poured, or laying a length of non-perforated but corrugated pipe across the trench (taping off ends) before pouring the grade beam. When the loop is installed, remove the tape and connect the loop to the short lengths passing through the grade beam. (See discussion in gravel option section on page 7.)

Installation Tip - connecting pipe loop to riser

The corrugated and perforated pipe should be connected to short pipe stubs and connected to opposite legs of a 4-inch PVC Tee. When 3-inch corrugated pipe is used, it can be inserted into the pipe stubs and secured with sheet metal screws. When 4-inch corrugated pipe is used, 4-inch by 4-inch rubber couplings can be used to connect the perforated pipe to the solid PVC pipe stubs.

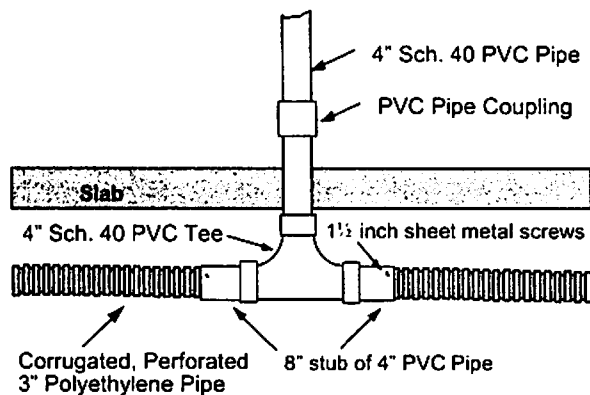

Soil Gas Collection Mat Option:

Sometimes it is cost-effective to use the native fills beneath a slab, but improve air movement by laying in a loop of perforated pipes or soil gas collection mats. When it is easy to dig a trench and lay in corrugated pipe, it makes sense to do so. However, when sub-grade soils are compacted, the ground is frozen, or labor is expensive soil gas collection mats are often used instead.

Soil gas collection mats consist of a plastic material that resembles an egg-crate. Wrapped around the "egg-crate" is a geotechnical filter fabric that allows for the passage of air, but prevents the infiltration of wet concrete. Because of this, the mat can be laid directly on top of the prepped sub-grade and the concrete poured directly over it.

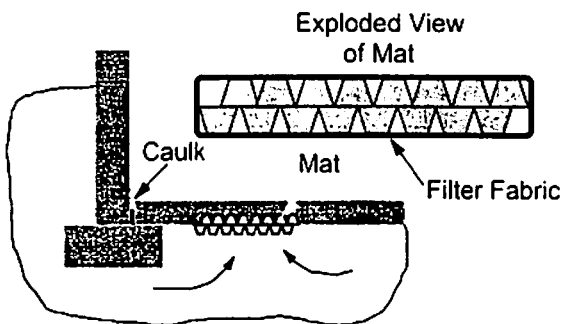

Soil gas collection laid on top of sub-grade

Mat is nailed down and concrete is poured directly over top.

Design Parameter - mat material and layout

For slab areas of 2,000 square feet or less, a continuous rectilinear loop of soil gas collection mat or drainage mat (with minimum dimensions of 1 inch in height by 12 inches in width and a nominal cross-sectional air flow area of 12 square inches) is laid on top of the sub-grade. The mat should be constructed of a matrix that allows for the movement of air through it, but should be capable of supporting the weight of the concrete above it. The matrix shall be covered with a geotextile filter cloth on all four sides, to prevent dirt or wet concrete from entering the matrix. All breaches and joints in the geotextile cloth should be repaired prior to pouring the slab. The loop is to be located just inside the

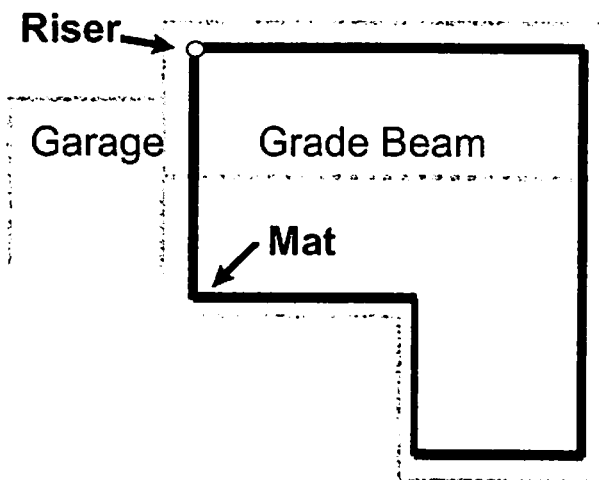

exterior, perimeter foundation walls, no farther than 12 inches from the foundation walls. In buildings where interior footings or other barriers separate the sub-grade area, install

the matting so that it penetrates these interior footings or barriers, in order to form a continuous loop around the exterior perimeter. Slabs larger than 2,000 square feet, but less than 4,000 square feet, require an additional strip of matting. This will bisect the loop and form two areas of equal dimension.

Installation Tip - making corners

When you come to a corner, cut the mat to the correct length. Then cut 12-inch slits on both edges of the mat and fold back the fabric. Cut similar slits in the piece that will attach to this corner at a right angle. Overlap the two cores and cut both of them simultaneously with a sharp knife, at a 45 degree angle. Butt the cut edges together. Fold the fabric from both ends over the joint and use duct tape to thoroughly seal the edges of the fabric, to keep concrete from entering. Drive in two or three 8-inch landscape staples to hold the joint down and to make sure that the two edges of the mat stay together.

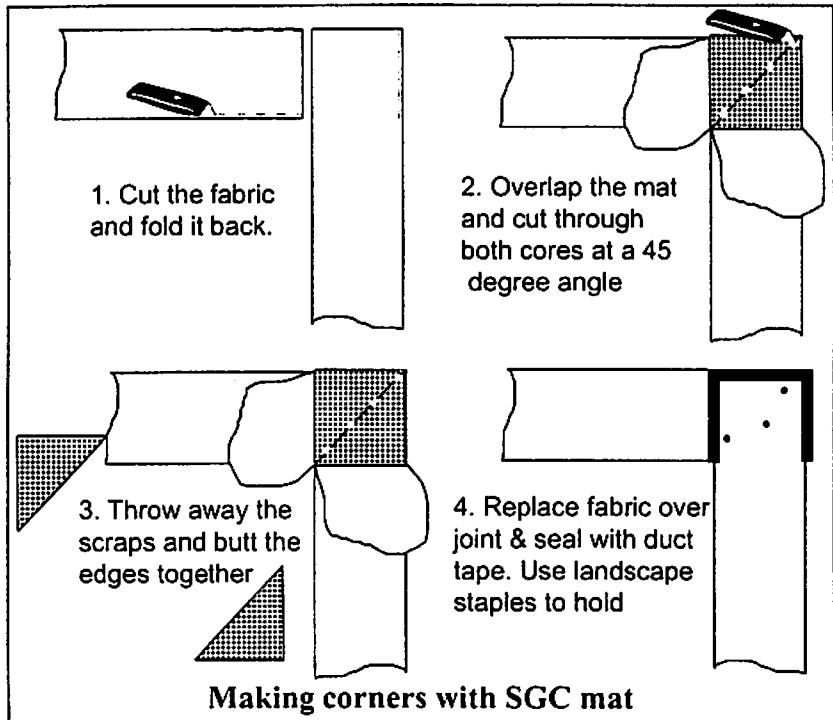

Installation Tip - making splices

When making splices, slit the fabric of the two ends to be joined. Lay the core from one end on top of the core to the other end, with a 3-inch overlap. Lay the fabric back over the top of the splice and thoroughly seal with duct tape, to keep the wet concrete from seeping in. Drive at least two 8-inch long staples through the mat at this point, being sure to drive them through at the point the two ends overlap.

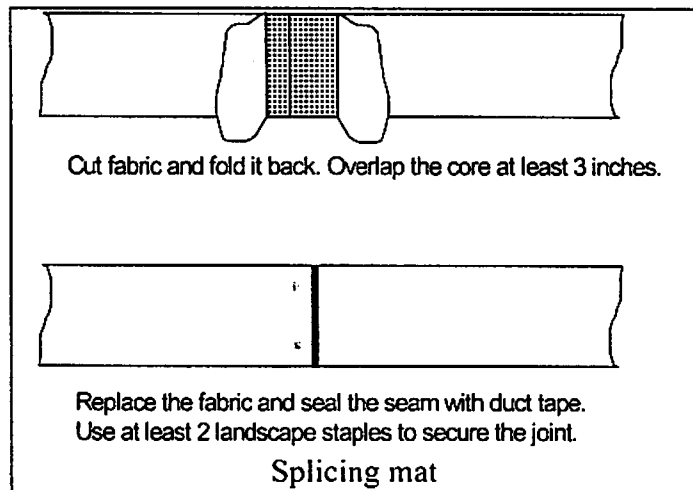

Installation Tip - making Tees in mat

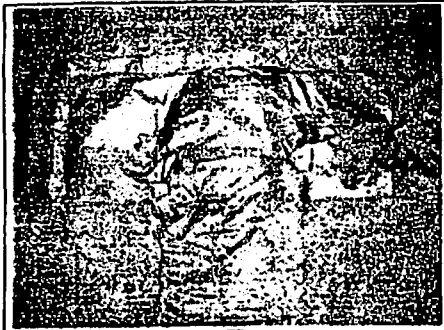

Mat Tees

There may be times when it is necessary to connect one length of mat to the middle of another length of mat. A Tee can be made by cutting back the geotechnical cloth, overlapping the interior matrix, replacing the cloth, securing with nails or landscape staples, and sealing openings in the geotechnical cloth with duct tape.

Installation Tip - securing the mat

To keep the mat in place while the concrete is poured, nail down the mat about every seven feet with 8-inch landscape staples or 60 penny nails.



Nail mat down

Installation Tip - repair cloth tears with duct tape

To ensure that wet concrete does not enter interior of mat, cuts and tears should be sealed with duct tape.

Design Parameter - connecting soil gas collection mat to system riser

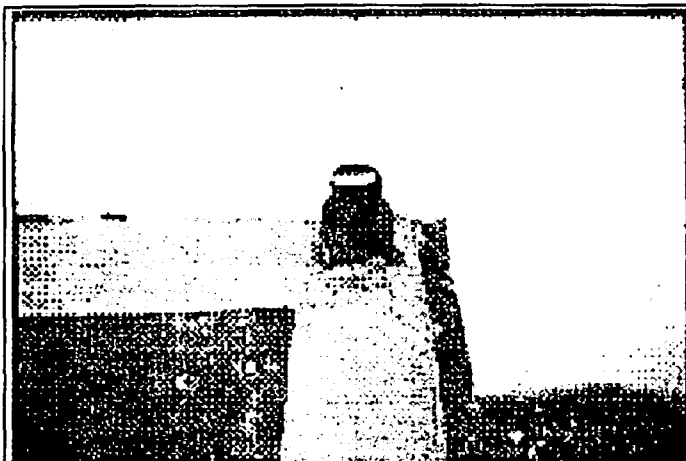

Tee Riser for mat

There is a special tee fitting that will accept the flat mat and adapt to a round vent pipe. Insert the mat into the flat ends. Tape the geotechnical fabric to the edges of the tee, to prevent wet concrete from entering. (The top of the tee is molded plastic, also to keep wet concrete from entering.) After the concrete is poured, cut the top with a hacksaw, insert a 4-inch riser, and caulk into place.

Note: There are some mats sold for radon reduction that are only

1/2 inch high and have one only side covered with a geotechnical cloth. If you use this material, be sure to use an adequate width (minimum 24 inches). The matrix will need to be covered with geotechnical cloth to keep concrete from entering. Do not cover with plastic strips because differential concrete drying can occur, causing a crack in the concrete along the edge of the plastic below the slab.

Installation Tip - seal off riser stub

Regardless of the sub-grade gas collection method used, you will have a short stub of pipe sticking up to which the vent piping system will later be attached. Care should be taken to:

- Cover the end of the pipe so it does not become filled with concrete when the slab is poured.
- Label the pipe so someone does not mistakenly think it is tied to the sewer and set a commode on it.
- Support the pipe so it stays vertical while the wet concrete is poured.



Installation Tip - sealing slab openings

Regardless of which method is used for collecting radon from beneath a slab, the system will work best if major openings through the slab to the sub-grade are sealed. When caulking slab openings it is best to utilize a polyurethane caulk that has excellent adhesion characteristics for concrete. Following are examples of some locations to caulk after the concrete slab has cured and before framing is installed.

Installation Tip - sealing floor-to-wall joints

Floor-to-wall joints are critical places to seal. Brush debris away from the joint before applying caulk. Apply enough caulk so when smoothed with a piece of cardboard (cut in a convex form) the caulk will both come out onto the floor and up the wall about 3/8 inch. The table below indicates the length of joint that an 11-ounce tube of caulk will cover.

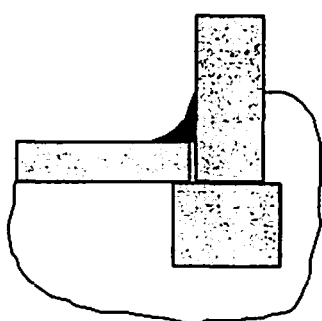

Cold Joint

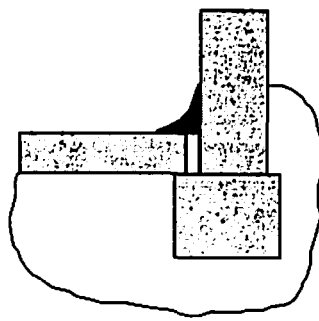

Expansion Joint

Joint type	Feet per 11 oz. tube
Cold	12
Expansion	8

Installation Tip - sealing control joints

Control joints in the concrete slab, whether saw-cut or made with grooving tools, should be filled with caulk. Even if they are not cracked now they will develop cracks in the future, so caulking them before floor finishes are in place makes a lot of sense. A gun-grade or flowable polyurethane can be used to fill these joints.

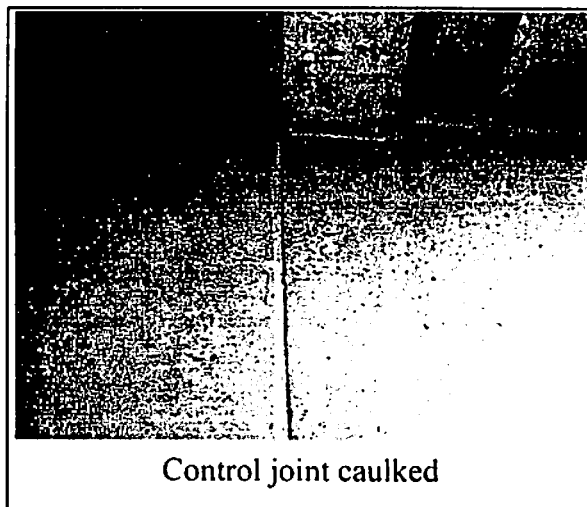

Installation Tip - sealing open sumps

If a sump has been installed to collect water from beneath the slab, let it do just that and do not tie your radon system into it. Although this is a technique that is often used in fixing existing homes, it is best to let the radon system collect radon and the sump system collect water. However, you will need to make sure that there is a lid on

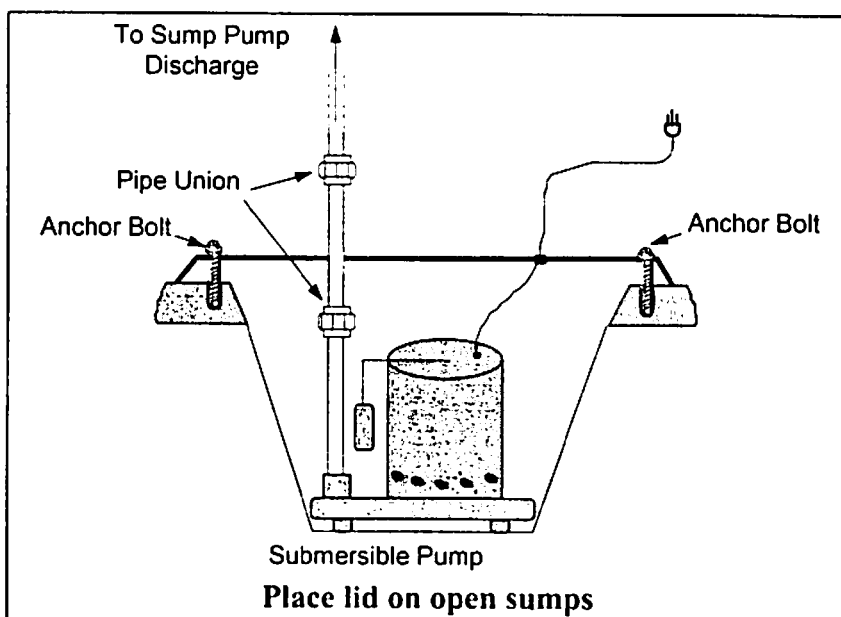

the top of the sump to prevent the leakage of interior air into the sub-grade, which can defeat your system. Label the lid, advising occupants that the lid is part of a radon reduction system and should be replaced if temporarily removed for pump maintenance.

Installation Tip - other places to seal

- Use a polyurethane caulk to seal around plumbing lines that pass through the slab and below-grade walls.
- Use plastic liners for tub and shower plumbing block-outs, or use silicone or tub and tile caulk to seal bases to floor.
- Use a full sill plate over the top row of block walls in basements, or make the upper row solid block.

Treating Crawl Space Areas

It is best to treat a large earthen area, such as a crawl space, by laying down a sheet of plastic with a perforated collection pipe beneath it, which is later connected to the radon vent riser. Seal the edges of the plastic to the foundation wall. Seal seams and penetrations as well.

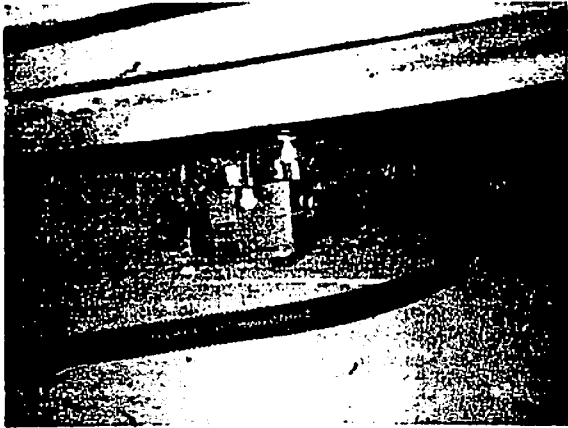

Corrugated pipe laid on crawl space floor

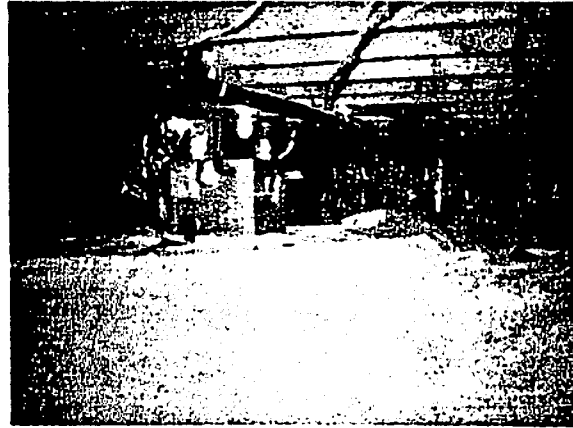

High density plastic laid on dirt, sealed to edges and pads

Design Parameter - type of plastic

The minimum thickness of plastic is a 6 mil polyethylene sheet. However, this material is not very durable if the crawl space will be accessed frequently or if occupants would like to use this area as storage. Typically, a more durable 4 mil cross-linked polyethylene is preferred for its high strength and durability. This high density plastic is also available in white, making the crawl space a lot brighter and user friendly for storage.

Design Parameter - amount of plastic

Be prepared with enough plastic to allow for a 12-inch overlap of seams. Bring the edges up the foundation walls about 12 inches to allow for proper adhesion. It is critical to allow for enough excess plastic so if a vacuum is drawn underneath it, the plastic can conform to the surface of the crawl space floor (like vacuum packaging). Otherwise, you will end up with the plastic stretched like a trampoline over any depressions in the dirt.

Design parameter - location of riser

The riser can be located anywhere in the crawl space - it does not need to be in the center. Place it where it will be convenient for routing the pipe up through the house, as well as for allowing access to the crawl space.

Design parameter - pipe beneath plastic

Use a minimum of 10 feet of 3-inch corrugated and perforated ADS pipe beneath the plastic sheeting.

Design Parameter - sealing edges und seams

Adhere the plastic to a concrete foundation wall by brushing it with a wire brush and running a 1/2" wide bead of polyurethane caulk along the wall. Plan on one 11-ounce tube to be able to do an 8-foot edge. It is a good idea to temporarily tape the free edge of the plastic so it will stay in place as the caulk cures. Place rocks on the plastic to keep it from being pulled off the walls as you work on the balance of the crawl space. Seal all seams with polyurethane caulk (8 feet/11 oz. tube).



Brush dirt from walls



Apply thick bead to walls



Press plastic onto wall

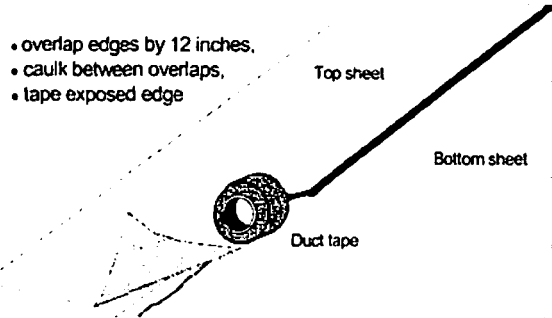

- overlap edges by 12 inches,
- caulk between overlaps,
- tape exposed edge

Continuous 1/2 inch bead of polyurethane caulk between overlapped sheets.

Caulk seam and use duct tape to hold free edge until caulk cures.

Installation Tip - vertical interferences

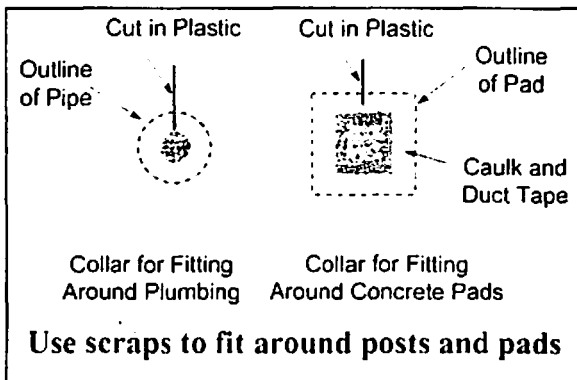

It is necessary to seal around posts and plumbing lines. You can use scraps of plastic to form aprons to fit around these obstructions. It is easier to seal your large sheet to a flat "apron" section than to try to fit it around the obstacle. Try to plan your seams along rows of piers.

When sealing around plumbing risers, make sure that the clean-out is accessible.

Design Parameter- riser installation

The radon vent pipe needs to be connected to the perforated pipe beneath the plastic in a manner that does not allow air leakage. One way to do this is to use two roof jacks. One roof jack goes below the plastic, and one is placed above the plastic, to allow for a flat area to which to seal the plastic. The riser is sealed by the rubber grommet on the roof jack. Secure the two roof jacks with sheet metal screws. Depending upon the location of the riser, there may be either a PVC Tee or an elbow beneath the plastic that has a short 4-inch stub of pipe, to which the corrugated and perforated pipe will be connected.

Riser for end of crawl space

Corrugated, Perforated
3" Polyethylene Pipe

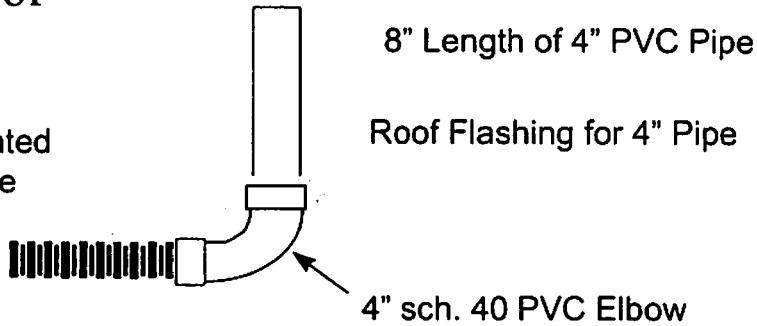

Riser detail when riser is at end of crawl space

Riser for center of crawl space

Corrugated, Perforated
3" Polyethylene Pipe

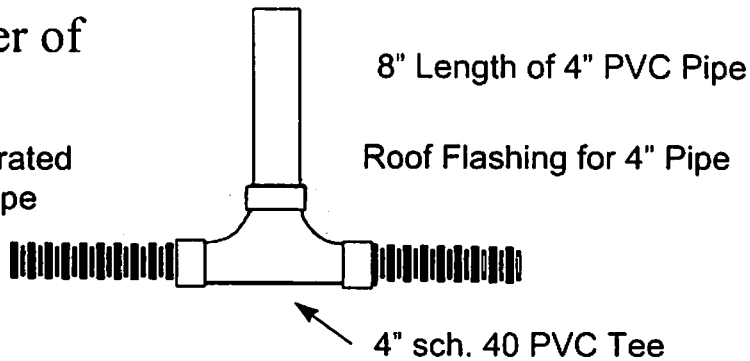

Riser detail when riser is more centrally located

Installation Tip: label riser and plastic

It is a very good idea to label the riser within the crawl space so it is not confused with any other plumbing. It is also a good idea to label the plastic to the effect that, if cut or damaged, it should be patched or replaced.

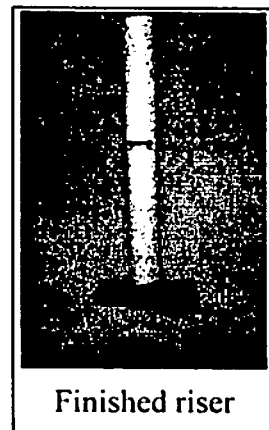

Combining Slab and Crawl Space Systems

It is common to find homes that have both a crawl space and a slab area. A typical configuration is shown in the figure below. Although one could treat the slab and crawl spaces separately, each with its own riser, it is more economical to tie the two together with a single riser. This requires that the pipe which connects the sub-slab area to the crawl space area be placed in the trench of the intervening footing, prior to pouring the foundation walls. This cross-over pipe should be 4-inch perforated and corrugated pipe to prevent accumulation of water, which would prevent air flow. Tape the ends of the cross-over to prevent debris from getting into the pipe, until it is connected to the slab and crawl-space systems.

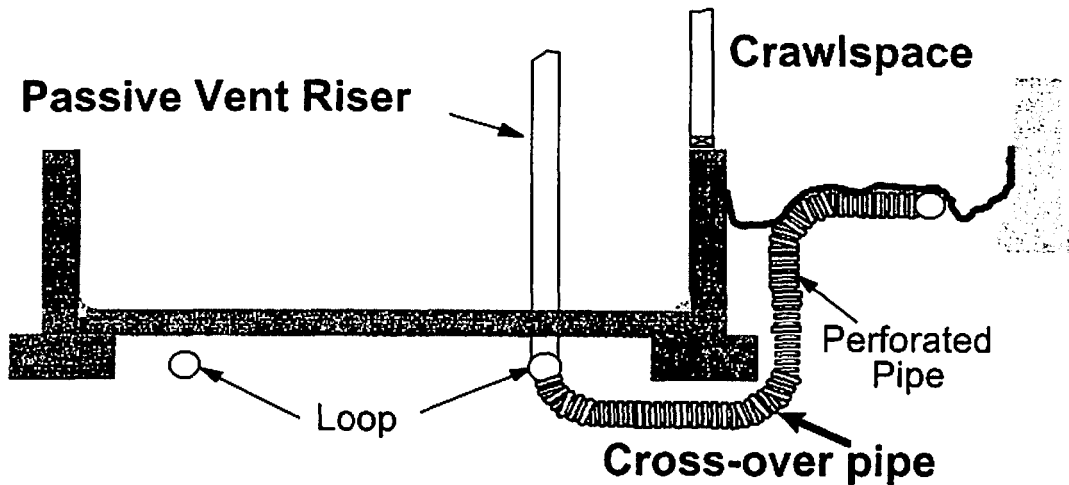

Combining Slab and Crawl Space Systems

Note: A pipe loop system is shown beneath the slab in the figure above. A similar method can be used to connect a soil gas collection mat beneath a slab to a perforated pipe beneath the plastic in a crawl space.

Installing Radon Vent Pipe

The purpose of the radon vent pipe is to exhaust radon collected from a slab or crawl space. One of the objectives of a radon system in a new home is to install it in such a manner that a natural draft occurs in the pipe to draw the radon from the soil without the use of a fan. The best way to accomplish this is to route the pipe up through a warm part of the house and exhaust it through the roof. There are a few tricks to this as detailed below.

Design Parameter - route pipe through warm spaces

One of the best places to run a vent pipe is through the same chase as the furnace and water heater flue. Do not tie them together, but do allow enough room to route the 4-inch pipe up alongside the flues, with proper clearances consistent with local fire codes and fire-ratings.

This means that the riser should be brought up through the slab within the same room as the furnace or water heater. This requires a little planning on your part, so as to spot this location before the slab is poured and to allow for sufficient room in the chase.

Do not route the pipe up through an outside wall or you will not get the necessary natural thermal stack effect. Routing the pipe up an outside wall will also make it difficult to install a fan in the attic if it is needed later on.

The vent needs to exit the roof at a location at least 10 feet away from the furnace flue. Plan to elbow the pipe away from the flue in the attic in order to maintain this separation above the roof.



Riser passing through slab in utility room

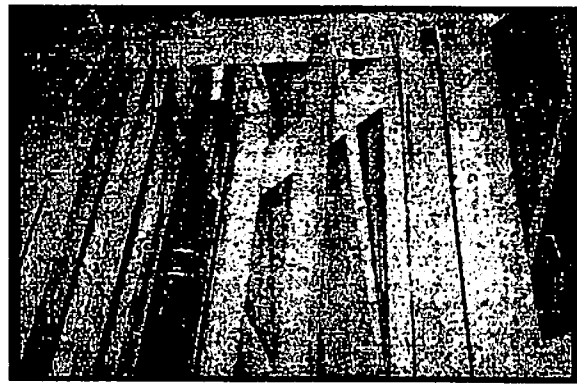

Vent routed along side flue for maximum stack effect

Design Parameter - type of pipe

The radon vent should be constructed with 4-inch, schedule 40 PVC or ABS pipe. Since it does not need to be pressure rated, drain, waste and vent pipes are the most cost-effective. Do not use thinner pipe or sheet-metal ductwork, due to the likelihood of breakage or leaks at joints. Prime and glue all joints in a similar manner as other indoor plumbing.

Installation Tip - do not trap the pipe

Air from the soil will have some moisture in it. As this air moves through any portion of the vent located in a cold space, such as an attic, the moisture can condense. It is important that this water can drain back down to the soil from which it came. Do not install traps in the pipe that will allow water to collect and restrict or stop air movement.

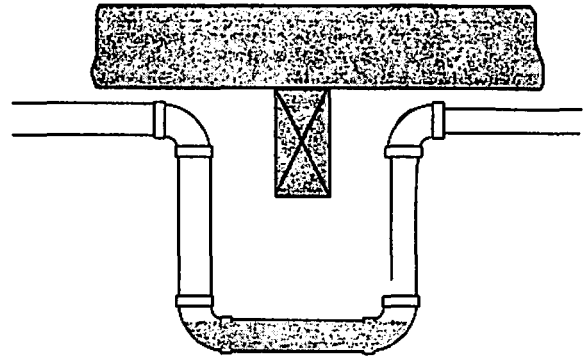
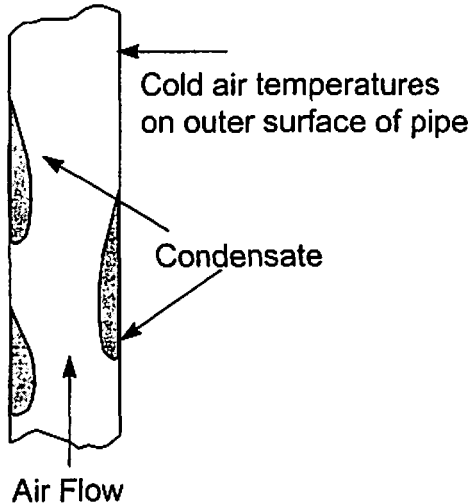

Traps will fill with water and not allow system to operate.

When planning the routing of your pipe, use minimal lengths of pipe and numbers of fittings. Do not use any traps.

Design Parameter - allow for the future installation of a fan

Although passive radon systems work very well, it is always a good idea to plan ahead. In the event that radon levels below 4.0 pCi/L are not achieved, or the occupant wants to lower the radon risk as much as possible, it may be necessary to install a fan. A few criteria for the location of a future fan are as follows:

1. Fans cannot be inside the living space of the house.
2. Fans cannot be in a crawl space beneath the home.
3. Fans are most often located in attics or garages.
4. Fans require a 30 inch *vertical* length of pipe for installation.
5. Place a junction box (with a 120 volt, non-switched duplex) within five feet of the potential location for a fan.

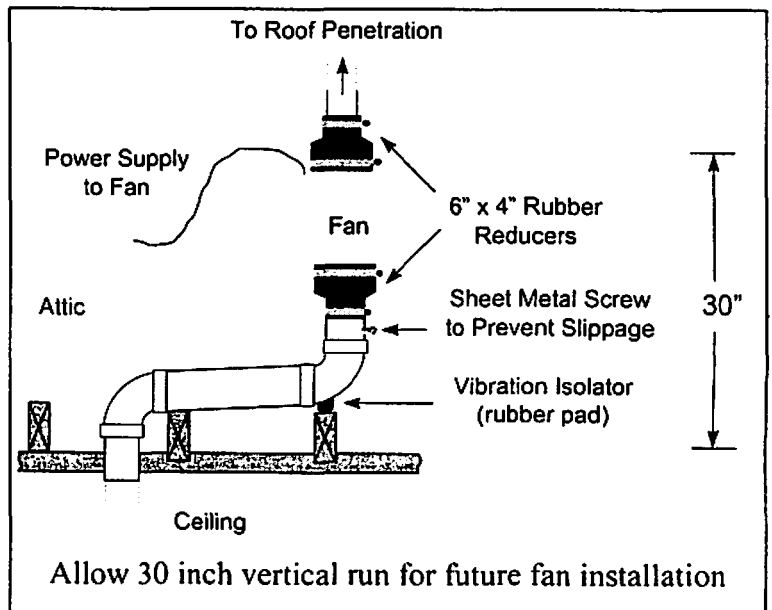

Design Parameter - maintain fire resistive rating of walls

If you route your vent pipe through the wall between the house and the garage, you will need to put a fire-barrier around the pipe (on the inside of the garage) to maintain the integrity of the wall. Install a fire barrier with a rating equal to the wall.

Note: Some ceilings are also fire rated and will require fire barriers as well.

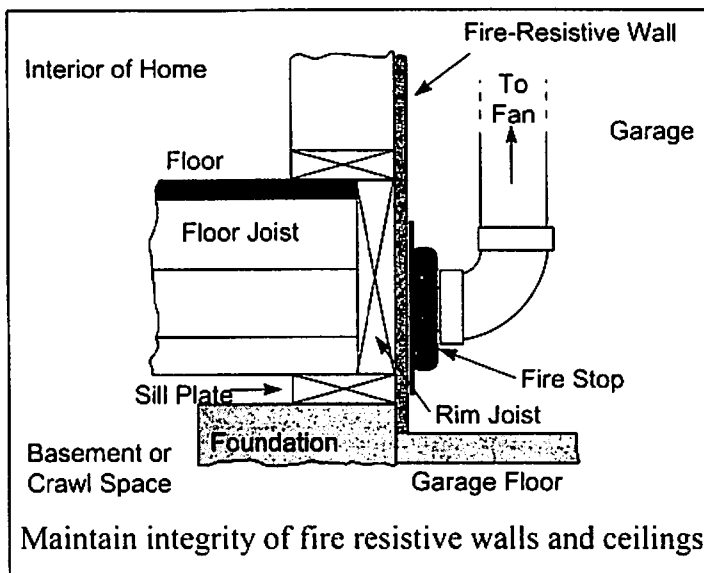

Design Parameter - discharge location

To prevent radon from re-entering the building through an open window, the U.S. EPA has established strict guidelines for the proper location of the exhaust point of the radon vent pipe. This criteria is as follows:

- A minimum of 10 feet above grade
- A minimum of 10 feet away from any building opening that is on a plane less than 2 feet below the discharge.

It is best to route the pipe up through the roof on the back side of the ridge, as you would a plumbing vent. Be sure to run the pipe up through the roof before the roofer installs the roof system. This will allow the roofer to properly flash around the pipe.

Installation Tip - screen on discharge

It is a good idea to put a screen on the discharge to keep birds out. There is no reason to put a rain cap on the end of the pipe. In fact, rain caps can force radon (if the system is activated) back down toward openings going into the living space. In other words, do not install a rain cap, but do put a ¼-inch screen on the end.

If you are in a high rainfall area, special devices (available from radon mitigation supply houses) can be put on the discharge to prevent large amounts of rain from entering the system, while still allowing air to vent up and away from the building.

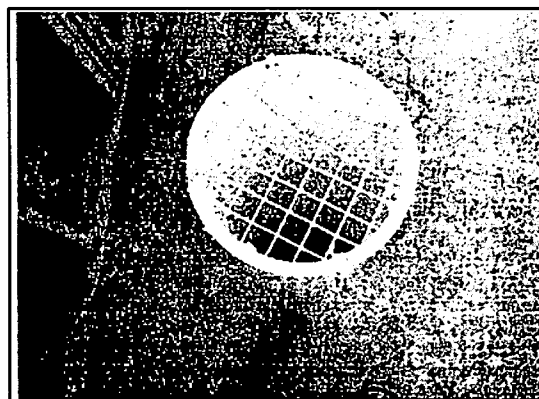

¼ inch rodent screen on discharge

Installation Tip - support the pipe

Support the pipe using plumbers' strapping at least once every 7 feet in horizontal runs, and once every 8 feet in vertical runs.

Installation Tip - label pipe



Label pipe in all locations where it can be seen by occupants and tradespeople.

It is important to label the exposed portions of the pipe, so that during construction other tradespeople recognize that the pipe is not part of the sewer system. It is also important to label the pipe for occupants and future occupants so they know that it is part of a "Radon Vent System." Places to label would include:

- Where riser exits slab.
- Where pipe is seen in closets.
- Pipe-run through attic.
- Pipe-run through garage (if it is routed there).

Post-Construction Testing

After the home is complete it is best to determine if the passive system is working properly. This test is typically performed by using a short-term radon test device located in the lowest portion of the home. The house should be closed up (except for normal entry and exit) 12 hours prior to and during the 48 hour testing period. This test should be performed after the house is finished and occupied, or operated as though occupied. This short-term test can be performed by a radon professional or by the occupant. The important thing is that the test be done, in order to determine if the system does or does not need to be activated with the addition of a fan. If this initial test has a result of 4.0 pCi/L or higher, a fan should be installed. A second test should be performed (after the fan has been running for 24 hours) in the same location as the initial test, to ensure that the active mitigation system is sufficiently reducing radon in the home.

Sequence of Installing System

The following flow chart may provide some guidance on planning the installation of radon reduction systems during new home construction.

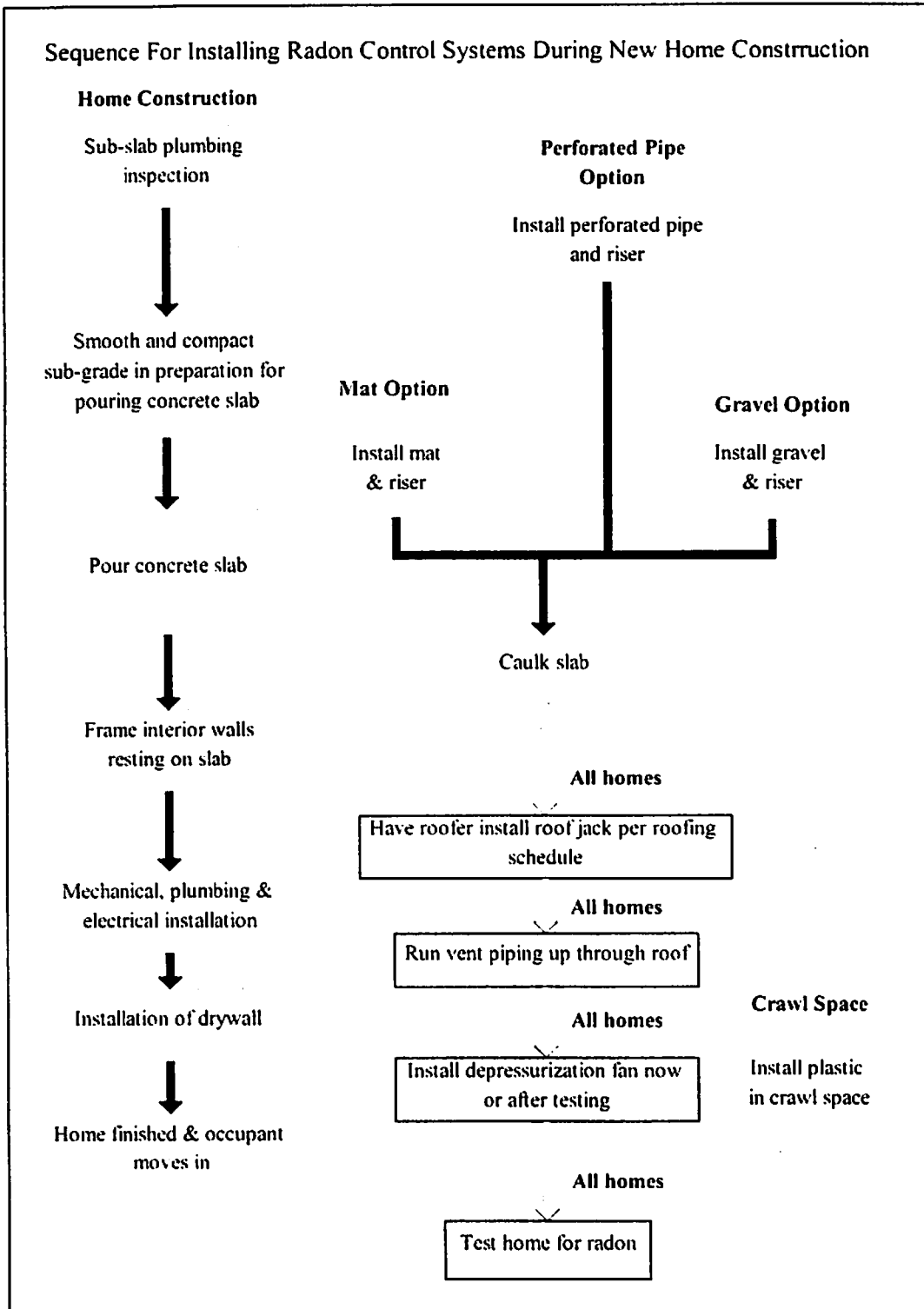

Summary

Installing a radon resistant system during the construction of a new home is not difficult nor is it very expensive, with a small amount of planning in advance. Furthermore, the skills necessary for installing the various parts of these systems are skills already available within existing trades used during the construction of a typical new home.

Installing these systems during construction makes good sense and provides a healthy home for those people who will live there for years to come.

Other References

This document has been written as a field guide for installing radon systems in new homes. The techniques described herein are those that have proven effective, but are not exhaustive in their review of all possible variations and techniques. For additional information on this topic, or on the health risks of radon or methods of fixing existing homes, the reader may wish to obtain copies of the following booklets.

1. U.S. Environmental Protection Agency, A Citizen's Guide to Radon, 2nd edition, 402-K92-001, May 1992.
2. U.S. Environmental Protection Agency, Consumer's Guide To Radon, 402-K92-003, August 1992.
3. U.S. Environmental Protection Agency, Home Buyer's and Seller's Guide to Radon, 402-R-93-003, March 1993.
4. U.S. Environmental Protection Agency, Model Standards and Techniques for Control of Radon in New Residential Buildings, 402-R-94-009.
5. U.S. Environmental Protection Agency, Radon Mitigation Standards, 402-R-93-078, rev. 4/97.

Radon Professionals

For a listing of individuals who provide radon measurement and mitigation services in the U.S. and are certified by the National Environmental Health Association's National Radon Proficiency Program visit their home page at <http://www.neha.org/>

Local Incidence of Radon

For more detailed maps indicating radon potential within your state, contact your state health department. This information is most often found in departments that deal with environmental health or radiation protection.

More Information and Associated Topics

For additional information on this document or for information on special training courses leading to being certified by the National Environmental Health Association as a radon professional, contact their National Radon Proficiency Program office at (800) 269-4174.